

COMPANY: EISCAT Scientific Association Sodankylä site		
TITLE: Channel Board Control and databus interface BM control logic and address counter		
SIZE:	DRAWING NO:	REV:
File:C:\padsprw\Logic\Itascho2.sch		
DRAWN: T.J.	DATE: 10.11.1999	MODIFIED: T1/MP 29.5.2000 layout ver 1.4
CHECKED:	DATE:	SHEET: 1 of 6

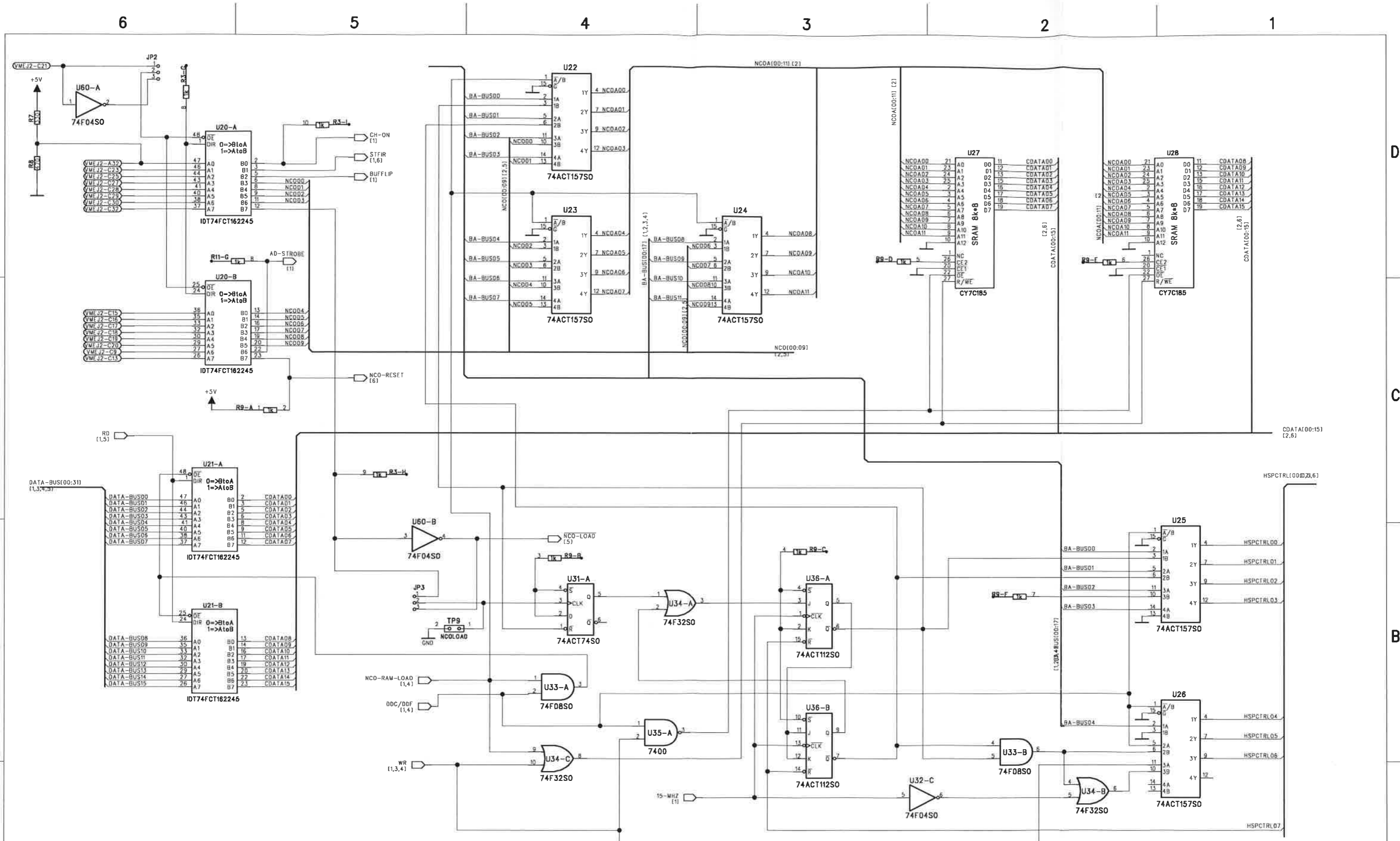

COMPANY:		EISCAT Scientific Association Sodankylä site	
TITLE:		Channel Board NCO Ram + Control	
SIZE:	DRAWING NO:	REV:	
DRAWN: T.I.	DATED: 8.11.1999	MODIFIED: layout ver. 1.4	DATED: 29.05.2000
CHECKED:	DATED:	SHEET: 2 of 6	

6

5

4

3

2

1

D

D

C

C

B

B

A

A

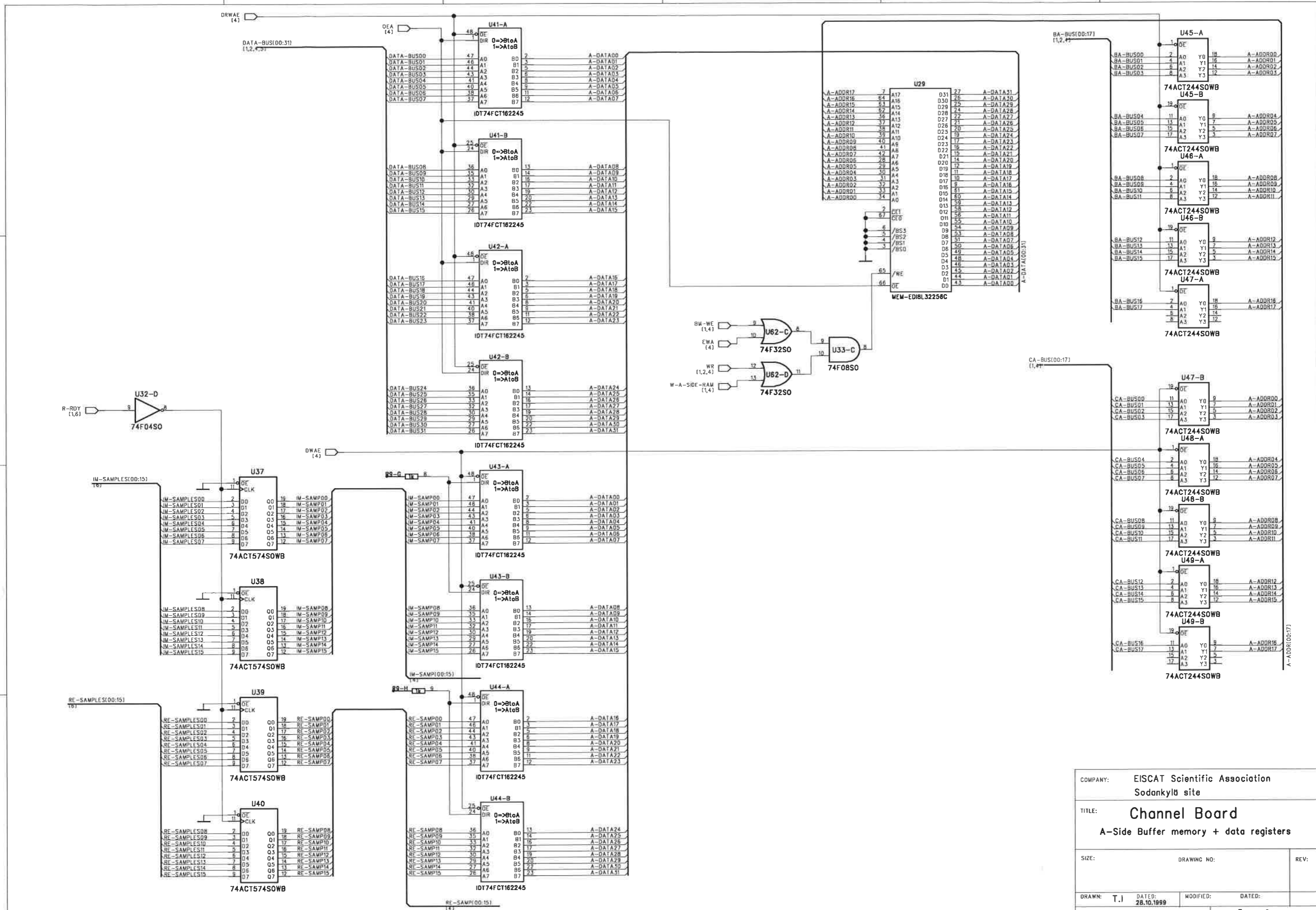

COMPANY: EISCAT Scientific Association Sodankylä site	
TITLE: Channel Board A-Side Buffer memory + data registers	
SIZE:	DRAWING NO: REV:
DRAWN: T.J. DATED: 28.10.1999	MODIFIED: DATED:
CHECKED: DATED:	SHEET: 3 of 6

D

D

C

C

R

B

A

A

DATA-BUS(00:31)  
(1,2,3,5)

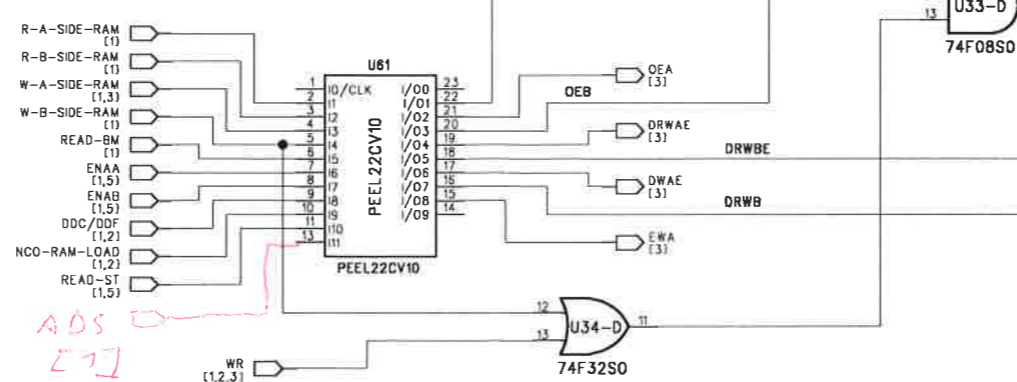
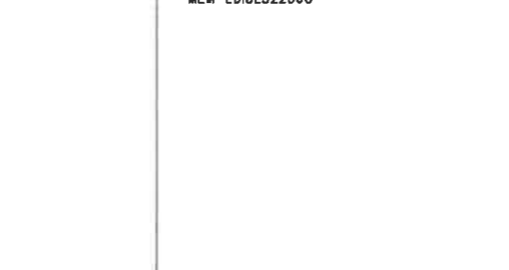
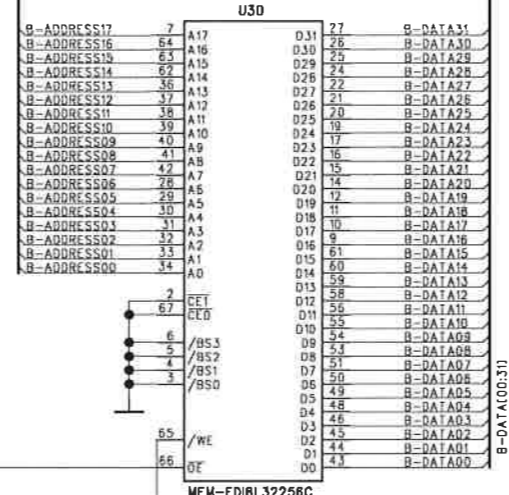
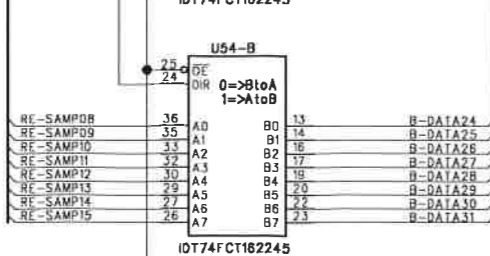
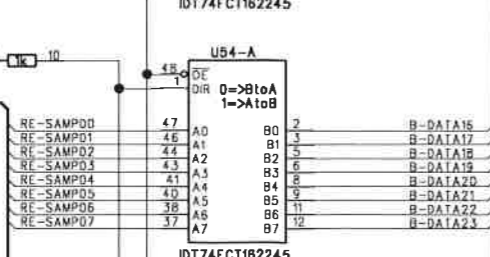
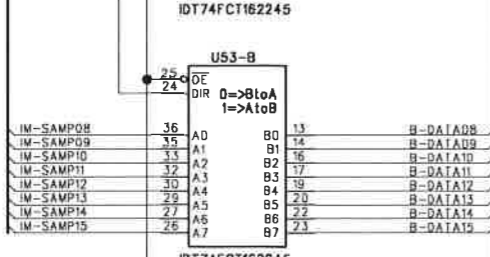
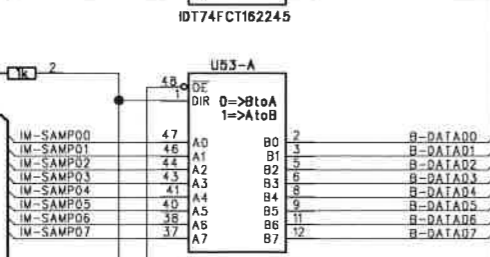
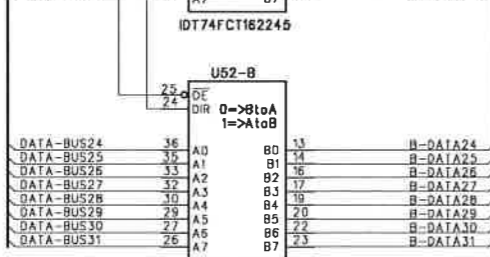
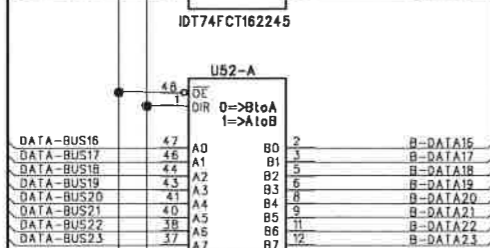
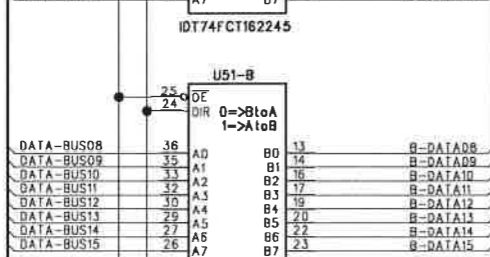
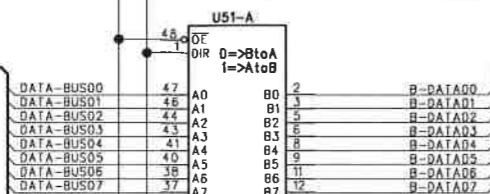

BA-BUS(00:17)  
(1,2,3)

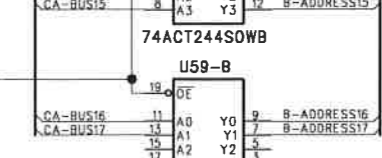
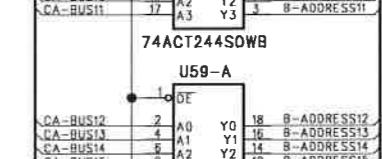
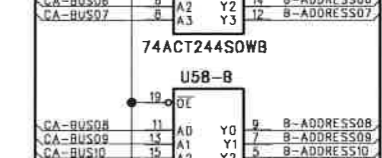
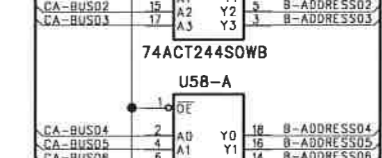
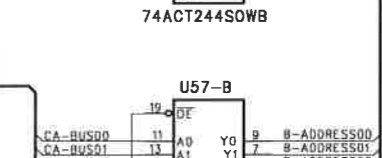
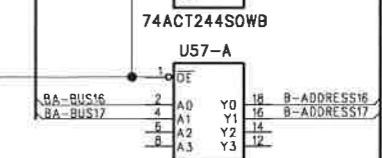
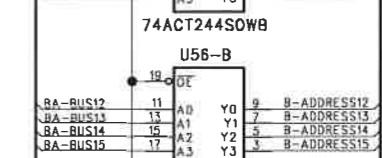
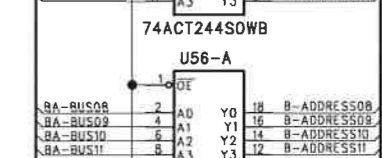
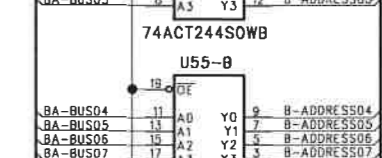
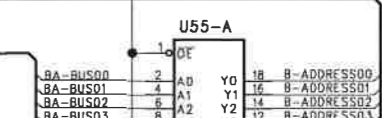

COMPANY: EISCAT Scientific Association  
Sodankylä site

TITLE: Channel Board

B-Side Buffer Memory + driver control PEEL

SIZE: DRAWING NO: REV:

DRAWN: T.J. DATED: 28.10.1999 MODIFIED: DATED:

CHECKED: DATED: SHEET: 4 OF 6

6

5

4

3

2

1

D

D

C

C

B

B

A

A

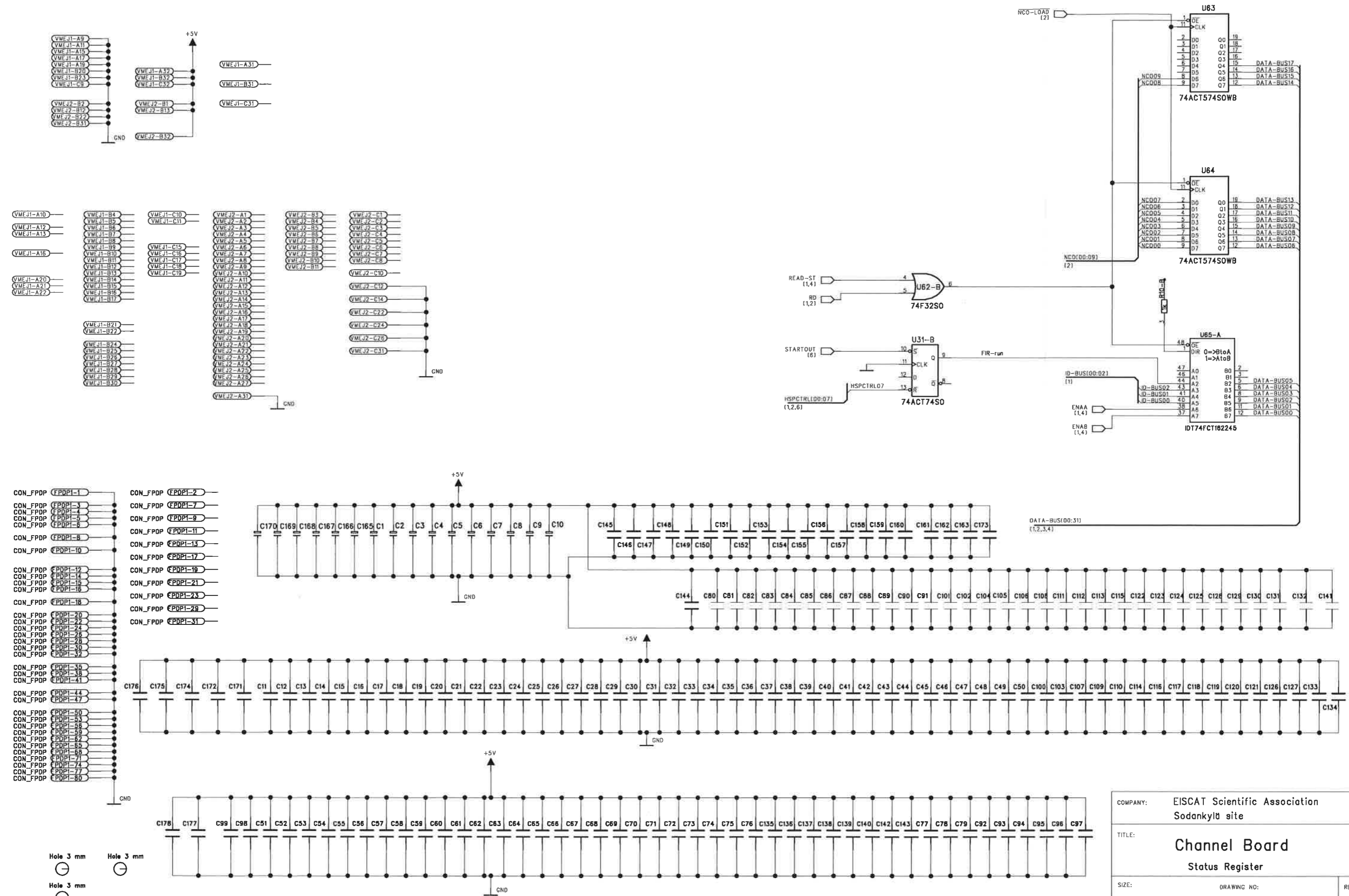

COMPANY:		EISCAT Scientific Association Sodankylä site	
TITLE:		Channel Board Status Register	
SIZE:	DRAWING NO:	REV:	
DRAWN: T.J.	DATED: 10.11.1998	MODIFIED:	DATED:
CHECKED:	DATED:	SHEET: 5 OF 6	

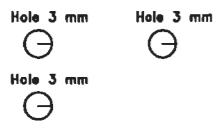

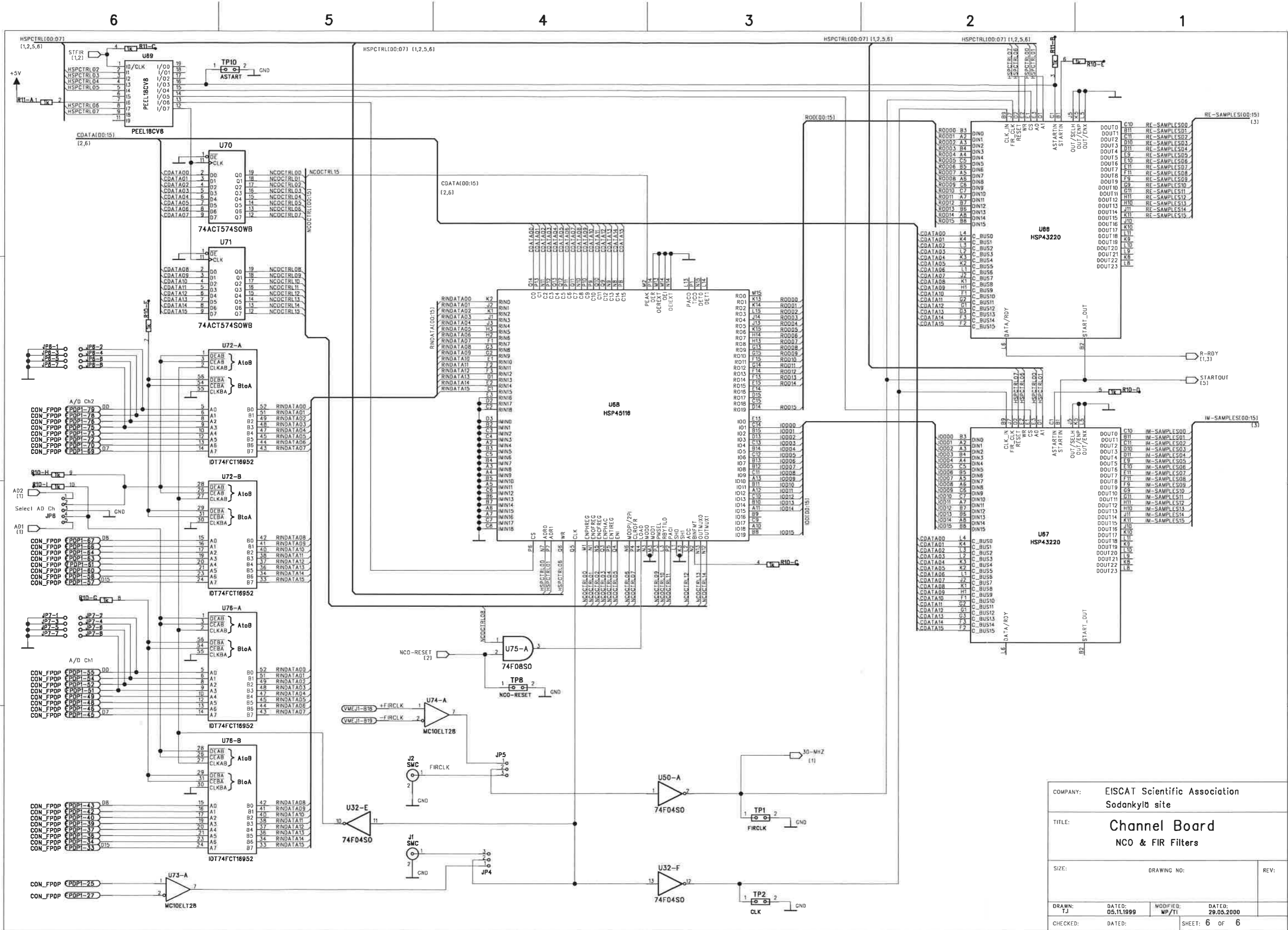

COMPANY:		EISCAT Scientific Association Sodankylä site	
TITLE:		Channel Board NCO & FIR Filters	
SIZE:	DRAWING NO:	REV:	
DRAWN: TJ	DATED: 05.11.1999	MODIFIED: MP/TI	DATED: 29.05.2000
CHECKED:	DATED:	SHEET: 6 OF 6	